



# 6004

## STRINGING MACHINE

### 6 POINT SC MOUNTING



**OWNER'S MANUAL**  
Issue 7 - June 2010



# 6004

## OWNER'S MANUAL

### TABLE OF CONTENTS

WARRANTY .....	PAGE 2
FEATURES.....	PAGE 3
PACKAGE CONTENTS.....	PAGE 4
ASSEMBLY INSTRUCTIONS .....	PAGE 5
MOUNTING THE FRAME .....	PAGE 8
STRINGING THE FRAME.....	PAGE 11
ADDITIONAL FEATURES .....	PAGE 12
PATHFINDER AWL.....	PAGE 13
MAINTENANCE & ADJUSTMENT .....	PAGE 14
TROUBLESHOOTING TIPS .....	PAGE 17
PARTS LIST .....	PAGE 18
PARTS DRAWING.....	PAGE 19

### LIMITED WARRANTY

GAMMA SPORTS ("GAMMA") warrants to the original purchaser that the GAMMA 6004 stringing machine ("EQUIPMENT") purchased is free from defects in materials and workmanship for a period of five (5) years from the date of original purchase for mechanical parts and for a period of one (1) year from the date of purchase for string clamps. Should any defects develop under normal use within the specified time periods, GAMMA will at its option, repair or replace the defective EQUIPMENT provided it is returned to GAMMA prepaid at the purchaser's expense. This warranty does not apply to any damage or defect caused by negligence, abuse, misuse, unauthorized alteration, shipping, handling or part wear and tear as a result of normal use.

Routine maintenance, adjustment and cleaning required to ensure proper operation are the responsibility of the purchaser and are not covered under the terms of this warranty. These include, but are not limited to: Linear Gripper Plate adjustment, as described on page 10, String Clamp adjustment, as described on page 16, tension calibration, as described on page 14, and Tensioner Brake adjustment, as described on page 15.

GAMMA's obligation under this warranty is limited to repair or replacement of defective EQUIPMENT, and no one is authorized to promise any other liability. GAMMA shall in no event be liable for any incidental or consequential damages.

To return defective EQUIPMENT, a return authorization (RA#) must be obtained from a GAMMA customer service representative by calling 1-800-333-0337. The RA# must be marked on the outside of the shipping carton being returned. All returns must be shipped prepaid by the customer to GAMMA. Please retain the original shipping carton and packing materials for any future shipments.

A GAMMA Care Service Plan is also available through GAMMA customer service, call 880.333.0337 for details.

# MACHINE FEATURES



## MACHINE FEATURES

- ❖ Manual Spring Tension Winder w/ 11 to 89 lbs Tension Range
- ❖ Patented Roller Guide for Maximum Accuracy and Consistency
- ❖ Parallel Jaw Gripper w/ Diamond Dust Coated Gripping Surfaces
- ❖ Professional Six Point Self-Centering “*Suspension Mount*” Racquet Mounting System- Accommodates All Racquets
- ❖ Professional “*Switch Action*” Dual Action, Rotating, Metal Fixed String Clamps w/ Diamond Dust Coating
- ❖ Full 360 Degree Turntable Rotation
- ❖ Large Convenient 141 sq. in. Tool Tray
- ❖ Height Adjustable from 36” to 48”



# 6004 Unpacking Instructions & Contents

## Instructions for Unpacking and Preparing for Assembly

The stringing machine is shipped in two cartons, a Master carton has the stringing machine floor stand, base legs, tensioner and accessories. The Mounting System Carton has the turntable, clamps and mounting system. **Please save the cartons and packing materials for possible shipments in the future.** Gamma Sports cannot be responsible for machines that are not returned, shipped in their original, undamaged packaging. The tools you will need to assemble the machine are provided with the machine.

Once the cartons are opened, remove all parts and check to be sure that all parts are present and accounted for.

### Contents of Master Carton

- (1) Lower Column Support Post
- (1) Upper Column Support Post
- (3) Short Legs w/ Adjustment Feet
- (1) Long Leg w/ Adjustment Foot
- (1) Bellows Set
- (1) Tool Tray w/ Pad
- (1) Tensioner Assembly
- (1) Tensioner Track
- (4) M8 x 25 Flat Head Screws
- (4) M8 x 30 Cap Screws
- (1) Tool Kit (contains side cutter, bent nose pliers & needle nose pliers)
- (1) Straight Stringers Awl & (1) Pathfinder Specialty Awl
- (1) Tools for assembly and maintenance

### Contents of Mounting System Carton

- (1) Turntable Assembly w/String Clamp Bases and Mounting Stands w/ Frame Support Slide, Side Supports and Adapters
- (2) String Clamps
- (1) Package of Spare plastic adapters for mounting system supports

# ASSEMBLY INSTRUCTIONS



## Base Leg Assembly

The stringing machine uses a four leg base design. The legs must be assembled to the lower column support before use. This is the larger of the two posts with the GAMMA label.

**Note:** For illustration purposes, the support column has been painted white for these instructions.



Align the holes in the leg flange with the matching holes in the lower column support post. Secure the leg with one FLAT HEAD cap screw through the upper hole, and one SOCKET HEAD cap screw through the bottom hole. Repeat this procedure for the three remaining legs.

## Base Foot Height Adjustment

Each foot of the Base Stand can be adjusted to compensate for uneven surfaces.

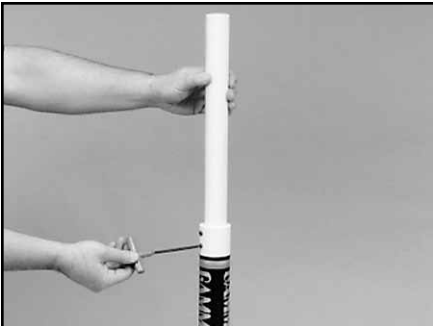

## Upper Column Support Assembly

The upper column support is shipped inside of the lower column support. Unloosen the two set screws at the top of the lower column support / base leg assembly. Extend the upper column to the maximum height and lock in place with the two set screws located at the top of the lower column support.

# ASSEMBLY INSTRUCTIONS

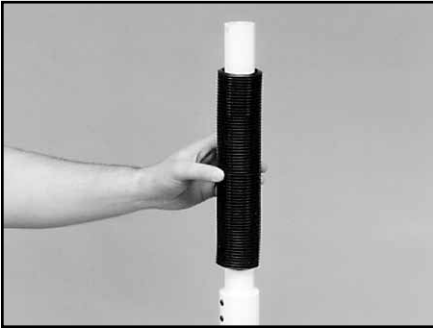

## Bellows Installation

The bellows assembly is supplied in two pieces and should be assembled as follows. Place the bellows section with the flange over the upper support column with the flange on the top. Place the remaining bellows over the upper support column and mate it with the flange on the lower bellows.

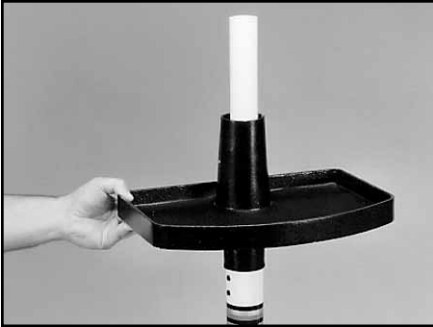

## Tool Tray Installation

Lower the tool tray over the top of the upper column support and let it rest loosely on the bellows assembly.



## Tension Track Installation

Place the tube of the tension track assembly over the top of the upper column support and align the tension track with the long leg of the base. Securely tighten the two socket set screws on the tension track assembly tube, locking it to the upper column support. Align the notch in the tool tray with the tension track bar while raising the tool tray. Secure the tray with the set screws in the side of the tray casting.

# ASSEMBLY INSTRUCTIONS

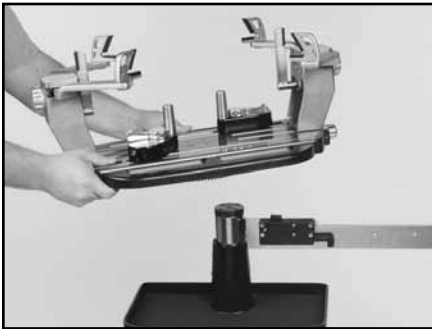

## Turntable and Mounting System Installation

To install the turntable remove the four nuts holding the mounting bolts in place during shipment. Position the turntable over the turntable pin and align the bolts with the holes in the flange. Secure them with the included allen wrench.

**Caution:** If the mounting bolts are removed or fall out during assembly be sure that the bolts pass through the spacer inside the turntable before securing the turntable to the turntable pin.

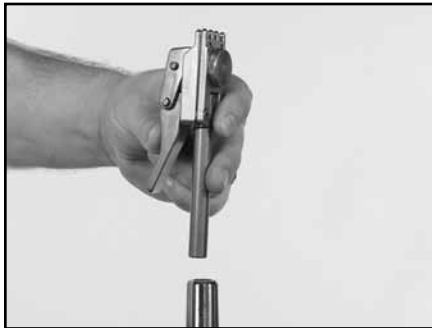

## String Clamp Installation

The post of the string clamp and tube of the string clamp base are treated with grease to provide protection against corrosion during shipping. Remove any excessive grease with a clean cloth prior to use. The post and tube may also be cleaned with isopropyl alcohol. After this type of thorough cleaning, the post and tube should be treated with a light coating of machine oil to protect the surfaces against corrosion and to ensure smooth operation.

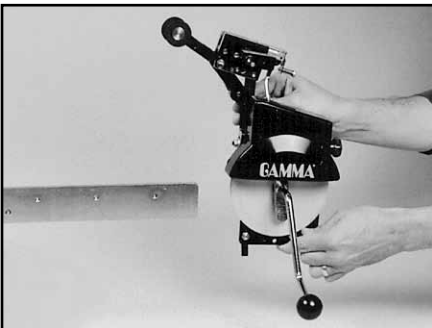

## Tensioner Installation

Remove the button head screw and washer located at the end of the tensioner bar with the 3mm hex wrench provided. Slide the tensioner onto the bar, being careful to align the bar with all of the bearings and the drive gear with the gear track. Replace the button head screw and washer in the end of the tensioner bar.

# ASSEMBLY INSTRUCTIONS

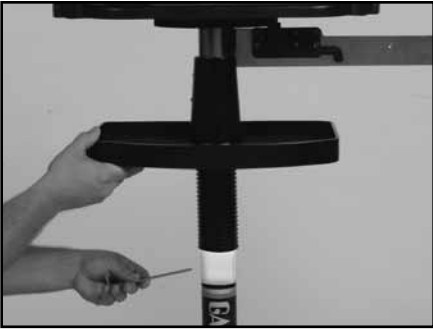

## Height Adjustment

The turntable height can be adjusted to suit the stringer. To adjust, loosen the two set screws on the lower column support post below the bellows assembly. Adjust the amount of engagement between the upper and lower column supports until the desired height is attained. Make sure that the tension track is still aligned with the long leg of the base and tighten the two set screws to lock the upper support column into place.

## MOUNTING THE FRAME



## Frame Support Post Adjustment

Place the racquet frame over the center support slide. Screw the post outward until the center support of the racquet support slide is positioned on the inside surface of the racquet frame.

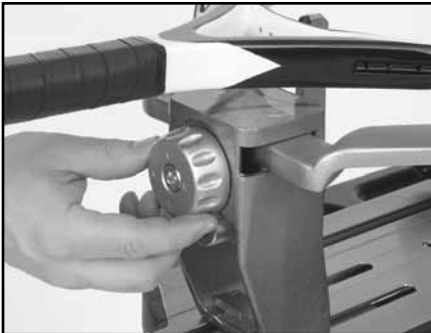

## Securing the Shoulder Supports

Secure the racquet frame with the shoulder supports by rotating the large adjustment knobs on the outside of the support post assemblies clockwise. Adjust the supports until firm contact is made between the shoulder supports and the frame.

The tear drop shaped holes towards the back of the shoulder supports are handy for holding the loose end of the string while pulling the string through the racquet. Simply insert the loose end into the tear drop shaped holes and slide the string into the point of the hole.



## MOUNTING THE FRAME



### Shoulder Support Adjustment

The shoulder supports are adjustable to provide support to the racquet frame. Swivel the support so that the pads will contact the frame squarely when the arms are closed against the racquet. Should the shoulder supports block string holes, adjust the position of the racquet between the arms until the shoulder supports contact the racquet between grommet holes.



### Frame Support Slide Adjustment

The Frame Support Slide should only be adjusted if the Shoulder Supports are blocking a grommet hole. Never unscrew the Frame Support Slide past the machined line on the lower horizontal portion.

Apply a final adjustment to all racquet support points until the racquet is firmly secured in the mounting system.

Should the frame supports lose contact with the frame while stringing, they should be adjusted, as needed, to maintain contact with the frame.

## BADMINTON MOUNTING



### Badminton Shoulder Support Protection Pad Installation

Slide the badminton shoulder support cover over the shoulder supports. There is no need to remove the tennis shoulder supports.

**Note:** An optional badminton frame support for the head of the racquet is available.

# STRINGING THE FRAME



## Clamp Base Operation

Rotate the base locking lever clockwise to secure the clamp base to the turntable.

Reverse the clamping procedure to unlock the string clamp. The locking lever is spring loaded to assist the unlocking of the clamp base.

The locking lever should be tightened enough to prevent clamp base slippage on the turntable, when the desired tension is placed on the string. To go from the loose position to the clamped position and back, generally

requires the travel permitted by the clamp base. If the travel is not sufficient to allow smooth operation of, adjust the clamp base as outlined on page 16.



## Clamp Head Operation

Switch Action Clamps are of a dual action design where as the clamp head and clamp base operate independently of one another.

To clamp a string, lift the clamp head and place the string between the jaws and depress the clamp head lever to secure the string. The clamping pressure applied to the string should be adjusted to provide sufficient pressure to secure the string when subjected to the desired pulling tension. The diamond coated gripper plates provide for increased friction

between the clamps and the string to allow for reduced clamping pressure while securing and holding the string under tension.

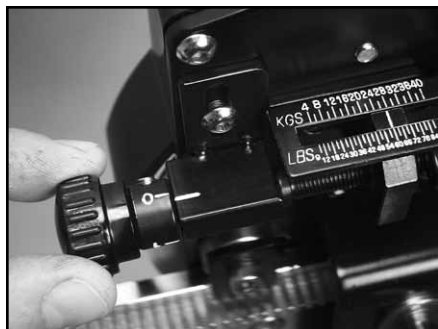

## Setting Tension

The spring tensioner utilizes a rotary adjusting knob along with a linear tension scale to indicate the tension setting. The scale is divided into 3 lb. increments and each 1/3 turn of the tension knob changes tension by 1 lb. To set the desired tension, rotate the tension knob and align the mark on the spring guide with the desired tension setting on the scale. When the "0" mark on the knob aligns with the line on the knob support the tension will be that indicated on the scale.

To increase tension by 1 or 2 lbs turn the knob counterclockwise until the "1" or "2" mark on the knob aligns with the line on the knob support. To decrease tension by 1 or 2 lbs, turn the knob clockwise until the "2" or "1" mark on the knob aligns with the line on the knob support.

# STRINGING THE FRAME

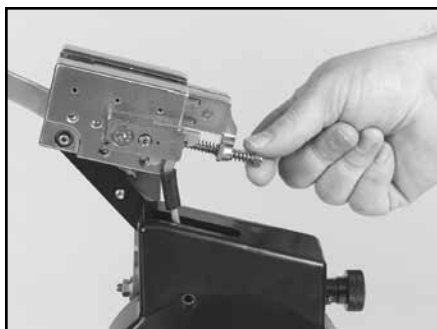

## Setting the Gripper Jaw Spacing

The gripper jaws of the tensioner are adjustable to accommodate varying string gauges.

If the string slips through the gripper jaws while pulling tension, rotate the gripper jaw adjustment screw counter-clockwise.

If the string is damaged while pulling tension, rotate the gripper jaw adjustment screw clockwise.

The jaws will be properly adjusted when there is enough pressure to securely grip the string without causing damage to the string.

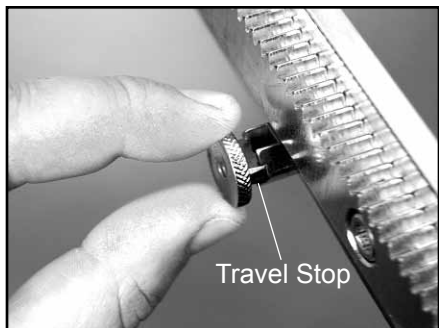

## Tensioner Travel Stop

To prevent contact between the tension head and the racquet and/or turntable, a travel stop is located about midpoint along the tensioner bar below the gear track. In the event the tension head must be moved closer to the racquet, pull and turn the travel stop 90 degrees. To re-engage the travel stop, simply pull and turn the travel stop 90 degrees.

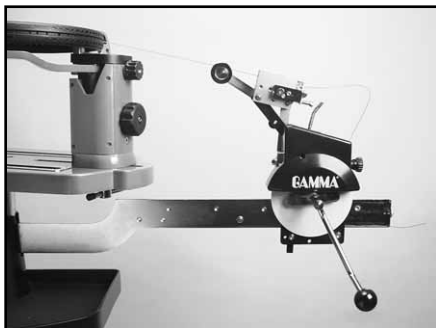

## Pulling Tension

Wrap the loose section of string once around the roller and insert the string between the diamond dust coated string gripper plates. Pull the string perpendicular to the gripper plates while slowly rotating the tensioner crank clockwise until the brake lever pops out of the latching block. The string is now tensioned and can be clamped in place with the remaining fixed clamp.

Repeat the above steps until all main strings are installed. Tie off ends of main strings as per racquet manufacturers recommendations.

# STRINGING THE FRAME

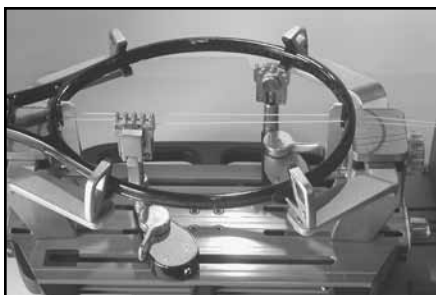

## Clamping the First Main String

To begin stringing the main strings, thread the two ends of the string through the two center holes at the appropriate end of the frame and continue through the opposite center holes. Thread one end of the string through the adjacent grommet hole and pull excess by hand. Secure one of the strings using a string clamp.

Pull the remaining end of the string with the tensioner to the desired tension. Secure the string with the remaining clamp.

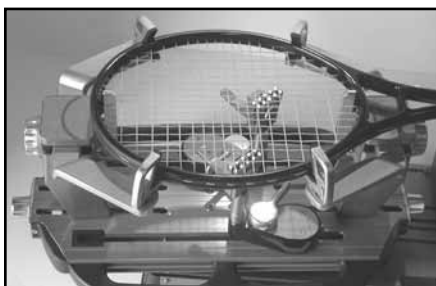

## Completing the String Job

Weave the cross strings over and under the main strings being careful to alternate the weave direction of each consecutive cross string so as to be opposite of the previously installed cross string.

Once the final cross string is tensioned and clamped, tie off at the appropriate hole specified by the racquet manufacturer.

# ADDITIONAL FEATURES

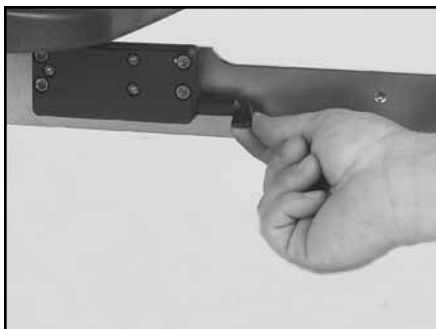

## Locking the Turntable

The turntable may be locked in any position.

The turntable winged lock knob is packed separately. Install the lock knob into the threaded hole located on the side of the tensioner bar post.

Rotate the knob clockwise to lock the turntable, and counter-clockwise to release the turntable.

# PATHFINDER AWL



The machine includes the pathfinder stringing awl which creates a pathway between or around strings to make inserting a string through blocked grommets easier and quicker.

Insert the awl through the grommet hole in the same manner as for traditional awls. The pathfinder awl must be in the closed position before insertion.



Once the awl is inserted, pull the handle of the awl outward while holding the tip section in place. This leaves the outer sheath in the grommet hole. Insert the end of the string into the outer sheath.

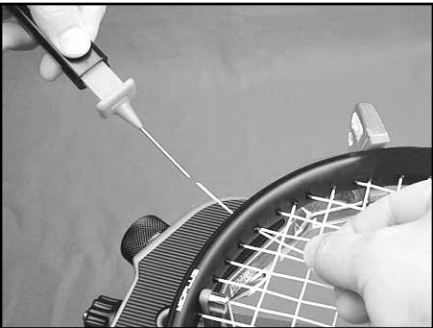

While holding the string, slowly pull the sheath out of the grommet hole to leave the free end of the string exposed.

# MAINTENANCE & ADJUSTMENTS



## Tension Calibration Procedure

Set the tension to 60 lbs. as indicated by the linear scale and rotary knob. Place the string on one end of a tension calibrator into a string clamp and secure. Place string located on the other end of the calibrator into the string tensioner and apply tension. If the brake lever releases before or after 60 lbs., the tension head should be calibrated as follows.

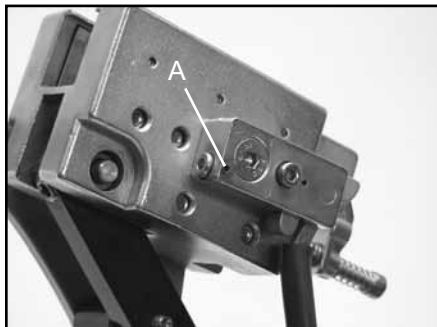

Loosen the 1.5 mm locking set screw (A) located on the side of the latching block as shown. The set screw is used to hold the adjustment screw in place.

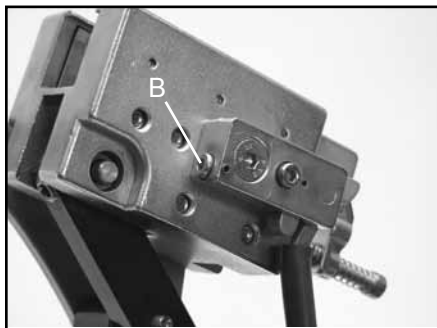

If the lever releases before 60 lbs., using the supplied L-shaped hex wrench, turn the adjustment screw (B) located on the left side of the latch block counter-clockwise to increase the engagement of the brake release latch with the brake lever. Repeat step 1 and adjust until the correct tension is indicated on the calibrator.

If the tension indicated in step 1 is greater than 60 lbs., turn the adjustment screw clockwise to reduce the engagement of the brake release latch with the brake lever. Repeat step 1 and adjust until the correct tension is indicated on the calibrator.

# MAINTENANCE & ADJUSTMENTS

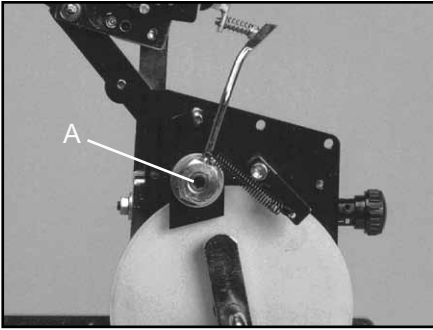

## Adjusting the Tensioner Brake

After stringing many racquets, the brake of the tensioner may need to be adjusted.

With the brake lever engaged in the latch, insert the 5mm allen wrench into the bolt (A) located at the base of the brake lever. It can be accessed through the hole on the face of the tensioner cover (above the 'GAMMA' logo).

**Note:** The tensioner cover does not need to be removed for the adjustment. The cover has been removed in the pictures for illustration purposes.

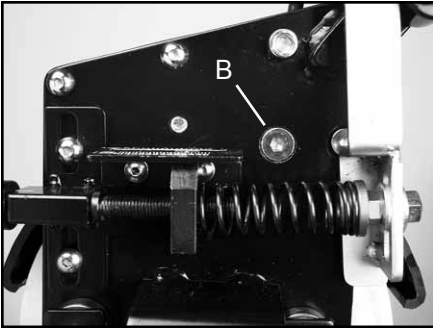

While holding the 5mm brake lever adjustment bolt (A), loosen the hex bolt (B) located on the back side of the tensioner frame with the 4 mm allen wrench.

**Note:** The hex bolt should only be loosened and must not be completely removed.

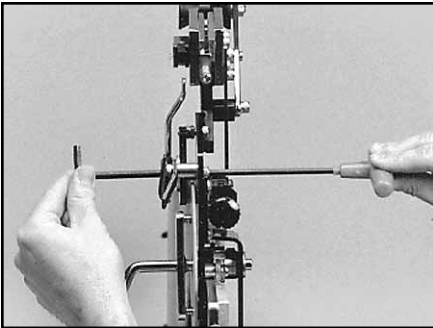

To tighten the braking mechanism, turn the set screw (A) counter clockwise by about 1/8 turn. Re-tighten the allen screw (B) on the back side of the tensioner frame and check for brake tightness. The tensioner should move freely along the track with the brake lever engaged and should hold tension with the brake lever released. If more adjustment is needed, repeat steps above until properly adjusted.

# MAINTENANCE & ADJUSTMENTS

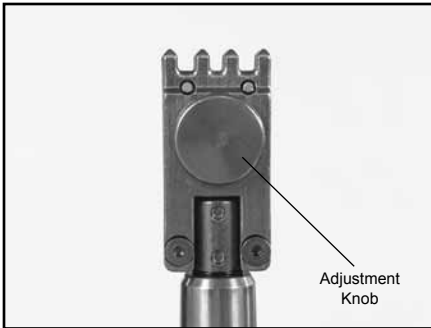

## String Clamp Adjustment

The string clamps will need minor adjustments according to string type, construction, and gauge.

To adjust the gap (clamping pressure) between the clamp jaws, insert the racquet as if you were beginning the main strings. Clamp the string and pull tension. If the string slips through the jaws of the clamp, tighten the clamp by compressing the clamp jaws together by hand while turning the Adjustment Knob, in the clockwise direction. If the clamp leaves impressions or

damages the string, it may be excessively tight and should be adjusted by turning the Adjustment knob counter clockwise to open the gap between the jaws. The clamp jaws should be cleaned periodically to be free from dirt, oil, and any string coating for them to grip properly.

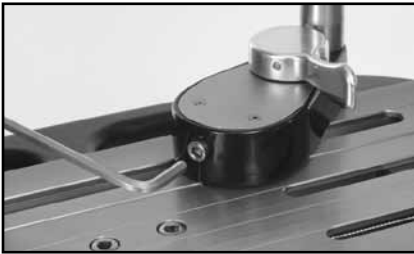

## Switch Action Clamp Base Adjustment

If the Switch Action clamp bases slip on the turntable, the base locking levers may need adjusted. Turn the hex screw clockwise to tighten the clamp and counterclockwise to loosen. If frequent adjustment is needed, remove the adjustment screw and tighten the two screws underneath of the clamp. Re-install the adjustment screw.



## Switch Action Clamp Base Removal

If the Switch Action clamp base needs to be removed, undo the 2 screws holding the FRP stop, underneath of the turntable. Remove the FRP stop and clamp for cleaning, adjustment or replacement.



# TROUBLESHOOTING TIPS

<u>PROBLEM</u>	<u>SOLUTION</u>
String slips in clamps	<ul style="list-style-type: none"><li>- Adjust gap between clamp jaws</li><li>- Clean clamp jaws</li></ul>
String slips in gripper	<ul style="list-style-type: none"><li>- Adjust gripper jaw stop screw</li><li>- Clean gripper jaws</li></ul>
String clamp base slips on turntable	<ul style="list-style-type: none"><li>- Clean bottom of clamp &amp; top of turntable with alcohol</li><li>- Adjust clamp base locking nut</li></ul>
String tension too tight or too loose	<ul style="list-style-type: none"><li>- Check tension using a tension calibrator, adjust machine calibration if necessary</li></ul>

## CARE & CLEANING

With time and use, the clamping surfaces of your machine may become oily or dirty and result in string or clamp slippage while stringing. Periodic cleaning of the String Clamps, String Clamp Base and String Gripper is recommended. Knife sharpening stones work well for cleaning the diamond coated string clamping surfaces. Cleaning with a solvent such as isopropyl alcohol and a mild abrasive tool such as a toothbrush also works well to remove oily or greasy build up.

# PARTS LIST

PART #	DESCRIPTION	TOOLS & ACCESSORIES	
6B	CAP SCREW- M8x30	98	10MM WRENCH*
104A	TENSIONER ASSEMBLY	109	NEEDLE NOSE PLIERS*
105	RETAINER SCREW	110	BENT NOSE PLIERS*
112	TOOL TRAY	171	DIAGONAL CUTTERS*
113	LONG LEG	251	HEX WRENCH SET*
114	SHORT LEG	MA	STRINGER'S AWL*
115	FLAT HEAD SCREW- M8x25	MBMSP	BADM SHLDER SUPP COVER
116	LOWER COLUMN SUPPORT	MFSP	FRAME SUPP PADS
119	BELLOWS		SHORT BADMINTON (SB)
120A	UPPER COLUMN SUPPORT		SQUASH (SQ)
121	LEVELING FOOT		TENNIS (T)
165	SET SCREW- M8x10		TAPERED BADMINTON (B)
203	TT SCREWS*	MMSPP	TENNIS SHLDER SUPP PADS
283	TT END CAP	MPG	STARTING CLAMP*
285	TT END CAP- RIGHT	MPS	CLEANING STONE*
286	TT END CAP- LEFT	MPSA	PATHFINDER AWL*
289	TT HANDLES		* (NOT SHOWN)
304	SC TT KNOB		
308	SC TT		
320	BRAKE RING		
327	TT PIN		
336	WINDER BAR		
337	BRAKE BOX		
339	BLACK SUSPENSION MT ARM		
340	SM TOP CAP		
341	SM BOTTOM CAP		
342	HEX FRAME SUPPORT		
MMSC	UNIVERSAL STRING CLAMP		
MSAC	SWITCH ACTION BASE CLAMP		

OPTIONAL TOOLS & ACCESS	
MBFS-11	BADM HEAD FRAME SUPP
MFSC	FLOOR STAND CASTERS
MGSMC	MACHINE COVER
MTC	CALIBRATOR
SGSM	STRINGER'S MAT

# PARTS DRAWING



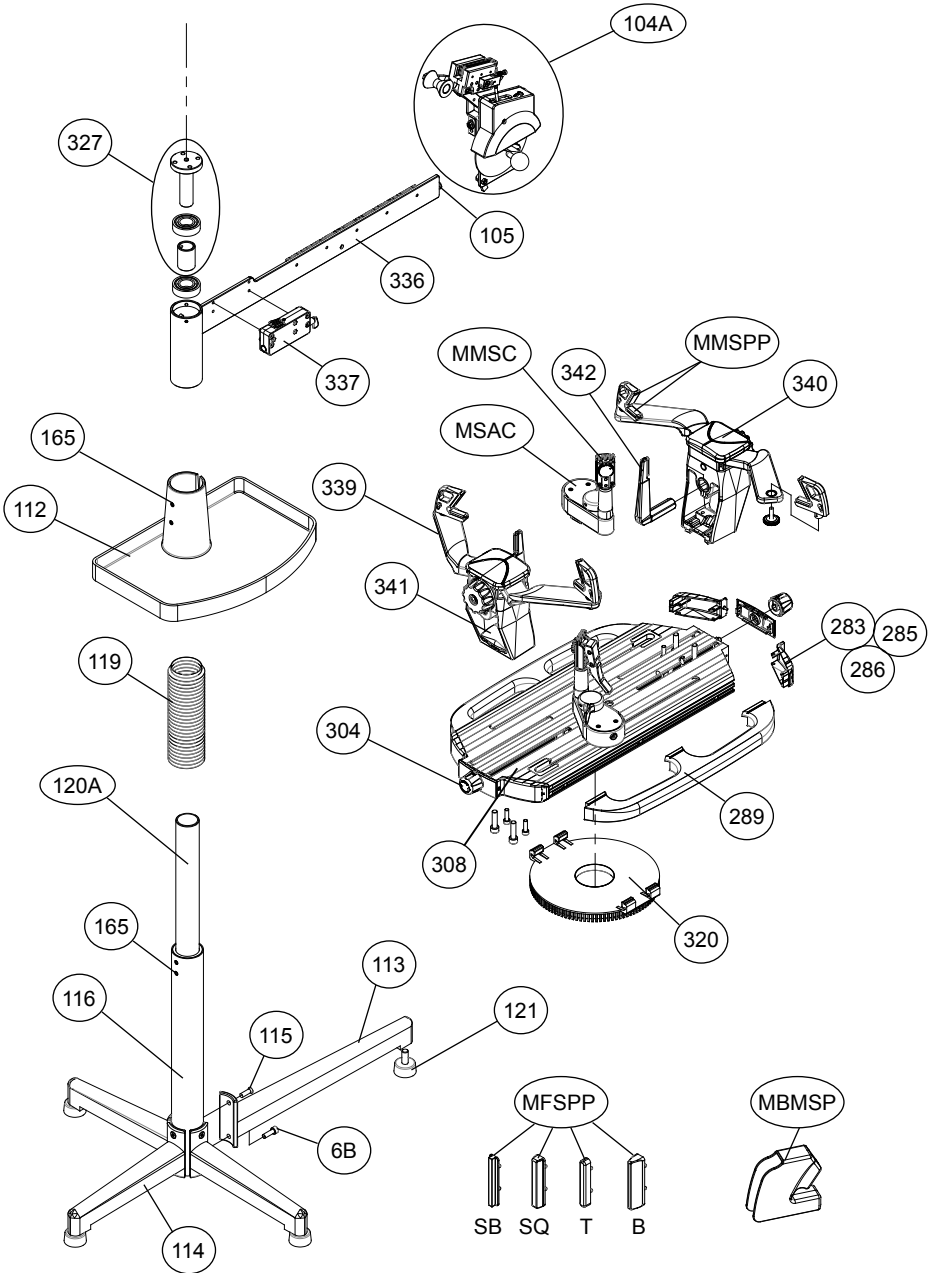

MMU2-38

**GAMMA SPORTS**

200 Waterfront Drive

Pittsburgh, Pennsylvania 15222

Phone: 800.333.0337 Fax: 412.323.0317

Visit our website at [www.gammasports.com](http://www.gammasports.com)