



6004 STRINGING MACHINE 2 POINT MOUNTING



OWNER'S MANUAL

Issue 1 - June 2006

6004

STRINGING MACHINE

TABLE OF CONTENTS

PAGE 1	WARRANTY
PAGE 2	FEATURES
PAGE 3	ASSEMBLY INSTRUCTIONS
PAGE 7	MOUNTING THE FRAME
PAGE 9	STRINGING THE FRAME
PAGE 11	PATHFINDER AWL
PAGE 12	MAINTENANCE & ADJUSTMENTS
PAGE 16	TROUBLESHOOTING
PAGE 16	CARE AND CLEANING
PAGE 17	COMPONENT IDENTIFICATION
PAGE 18	PARTS LISTING

LIMITED WARRANTY

GAMMA Sports (GAMMA), warrants to the original purchaser that the stringing machine ("EQUIPMENT") purchased is free from defects in materials and workmanship for a period of five (5) years from the date of original purchase for mechanical parts (excluding string clamps), and for a period of one (1) year from the date of purchase for string clamps. Should any defects develop under normal use within the specified time periods, GAMMA will at its option, repair or replace the defective EQUIPMENT provided it is returned to GAMMA prepaid at the purchaser's expense. This warranty does not apply to any damage or defect caused by negligence, abuse, misuse, unauthorized alteration, shipping, handling, or part wear and tear as a result of normal use.

Routine maintenance, adjustment, and cleaning required to ensure proper operation are the responsibility of the purchaser and are not covered under the terms of this warranty. These include, but are not limited to: Linear Gripper Plate adjustment, as described on page 7, tension calibration, as described on page 12, Tensioner Brake adjustment, as described on page 13, String Clamp adjustment, as described on page 14, Switch Action Clamp Base adjustment, as described on page 14, and replacement of the Turntable Brake Pad, as described on page 15.

GAMMA's obligation under this warranty is limited to repair or replacement of defective EQUIPMENT, and no one is authorized to promise any other liability. GAMMA shall in no event be liable for any incidental or consequential damages.

To return defective EQUIPMENT, a return authorization (RA#) must be obtained from GAMMA customer service. The RA# must be marked on the outside of the shipping carton being returned. All returns must be shipped prepaid by the customer to GAMMA. Please retain the original shipping carton and packing materials for any future shipments. GAMMA will not be responsible for machines which are not sent in the original undamaged packaging.

MACHINE FEATURES



- ❖ Manual Spring Tensioner
- ❖ Diamond Coated String Gripper
- ❖ Tension Range: 11lbs. - 89lbs.
- ❖ 2 Point Self-Centering Mounting System (4 Points of Support)
- ❖ Switch Action Cam Lock Dual Action Metal String Clamps w/ Diamond Coating
- ❖ Full 360 Degree Turntable Rotation
- ❖ Precision Bearing Mounted Turntable
- ❖ Large Convenient 141 sq. in. Tool Tray
- ❖ Height Adjustable From 36" to 48"

ASSEMBLY INSTRUCTIONS



Base Leg Assembly

The GAMMA 6004 stringing machine uses a four leg base design. The legs must be assembled to the support post before use. Remove the lower column support from the carton.



Align the holes in the leg flange with the matching holes in the lower column support post. Secure the leg with one FLAT HEAD cap screw through the upper hole, and one SOCKET HEAD cap screw through the bottom hole. Repeat this procedure for the three remaining legs.

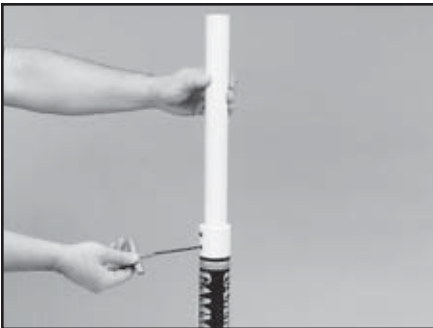

Upper Column Support Assembly

Insert the upper column support into the lower column support / base leg assembly. Leave the upper column extended to maximum height and lock in place with the two set screws located at the top of the lower column support.

ASSEMBLY INSTRUCTIONS

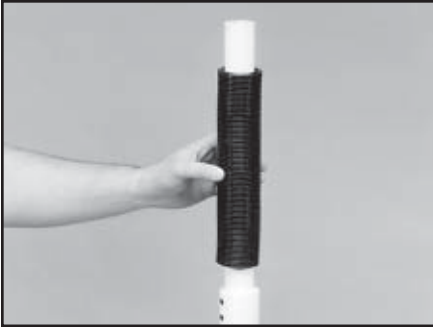

Bellows Installation

The bellows assembly is supplied in two pieces and should be assembled as follows. Place the bellows section with the flange over the upper support column with the flange on the top. Place the remaining bellows over the upper support column and mate it with the flange on the lower bellows.



Tool Tray Installation

Lower the tool tray over the top of the upper column support and let it rest loosely on the bellows assembly.



Tension Track Installation

Place the tube of the tension track assembly over the top of the upper column support. Align the tension track with the long leg of the base assembly. Securely tighten the two socket set screws on the tension track assembly tube, locking it to the upper column support. Align the notch in the tool tray with the tension track bar while raising the tool tray. Secure the tray with the set screws in the side of the tray casting.

ASSEMBLY INSTRUCTIONS

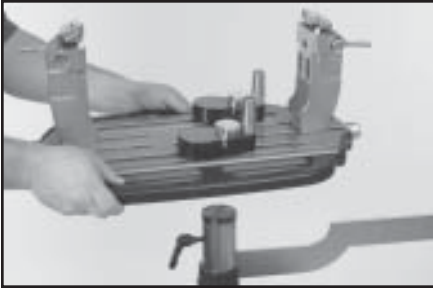

Turntable Installation

Remove the nuts from underneath of the turntable. Position the 4 screws over the flange of the turntable pin. Engaging the turntable brake helps position the screws.

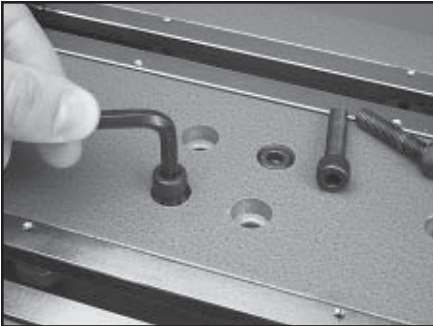

Attach the turntable to the turntable pin flange using the 4 included M6 cap screws. Tighten securely.

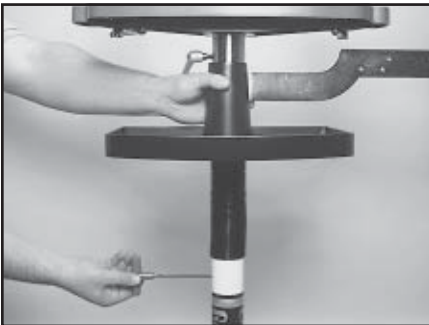

Height Adjustment

The turntable height can be adjusted to suit the stringer. To adjust, loosen the two set screws on the lower column support post below the bellows assembly. Adjust the amount of engagement between the upper and lower column supports until the desired height is attained. Make sure that the tension track is still aligned with the long leg of the base and tighten the two set screws to lock the upper support column into place.

ASSEMBLY INSTRUCTIONS



Clamp Head Installation

The post of the string clamp head and the tube of the string clamp base are treated with grease to provide protection against corrosion during shipping. Remove any excessive grease with a clean cloth prior to use. The post and tube may also be cleaned with isopropyl alcohol. After this type of thorough cleaning, the post and tube should be treated with a light coating of machine oil to protect the surfaces against corrosion and to ensure smooth operation.

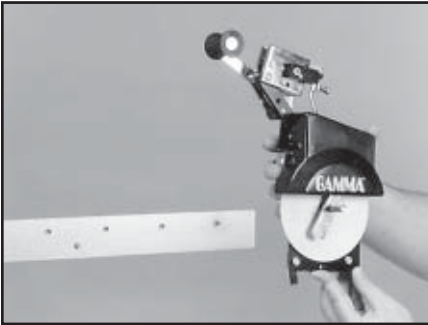

Tensioner Installation

Remove the button head screw and washer located at the end of the tensioner bar with the 3 mm hex wrench provided. Slide the tensioner onto the bar, being careful to align the bar with all of the bearings and the drive gear with the gear track. Replace the button head screw and washer in the end of the tensioner bar.

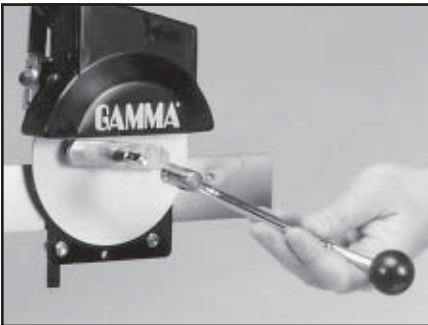

Crank Arm Installation

Remove the flat head screw located on the crank shaft with the 2.5mm wrench provided. Slide the crank handle over the crank shaft while aligning the holes. Replace the flat-head screw.

ASSEMBLY INSTRUCTIONS

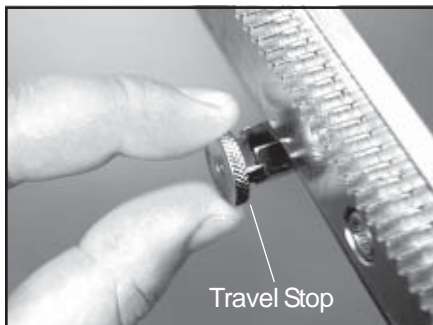

Note: The tensioner bar is equipped with a tensioner travel stop to limit travel of the tensioner along the bar and prevent contact between the tensioner and the racquet mounting system while stringing. The travel stop is located about midpoint along the tensioner bar below the gear track.

To disengage the stop, pull and hold the knob, rotate 90 degrees and release. To engage the stop, repeat the above procedure until the travel stop pin protrudes beyond the opposite surface of the tensioner bar.

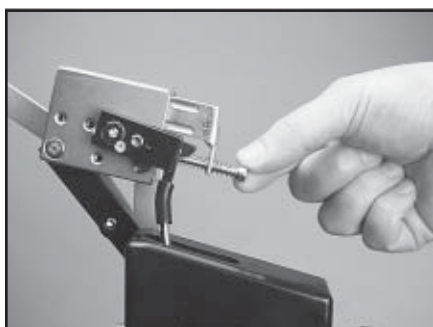

Setting the Gripper Jaw Spacing

The gripper jaws of the 6004 tensioner are adjustable to accommodate varying string gauges.

If the string slips through the gripper jaws while pulling tension, rotate the gripper jaw adjustment screw counter-clockwise.

If the string is damaged while pulling tension, rotate the gripper jaw adjustment screw clockwise.

The jaws will be properly adjusted when there is enough pressure to securely grip the string without causing damage to the string.

MOUNTING THE FRAME



Adjusting the Inner Racquet Supports

The white racquet supports are adjustable to accommodate all racquets and provide maximum support to the racquet frame. Screw the the pads up or down so they contact the frame at a maxium height without blocking the grommet holes.

MOUNTING THE FRAME

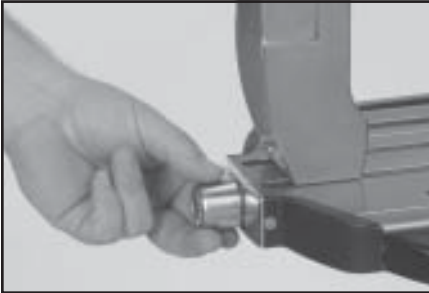

Mounting Post Adjustment

Place the racquet frame over the white racquet supports. Screw the the post outward until the racquet supports are positioned on the inside surface of the racquet frame.



Installing the Racquet Hold Down

With the lever in the up position, insert the racquet hold down into the hole in the center of the mounting post.



Securing the Racquet Hold Down

Depress the racquet hold down lever to secure the racquet frame.

STRINGING THE FRAME

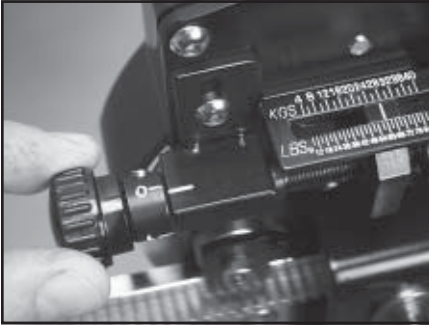

Setting Tension

The spring tensioner utilizes a rotary adjusting knob along with a linear tension scale to indicate the tension setting. The scale is divided into 3 lb increments and each 1/3 turn of the tension knob changes tension by 1 lb. To set the desired tension, rotate the tension knob and align the mark on the spring guide with the desired tension setting on the scale. When the "0" mark on the knob aligns with the line on the knob support the tension will be that indicated on the scale. To increase tension by 1 or 2 lbs turn the knob counter-

clockwise until the "1" or "2" mark on the knob aligns with the line on the knob support. To decrease tension by 1 or 2 lbs, turn the knob clockwise until the "2" or "1" mark on the knob aligns with the line on the knob support.

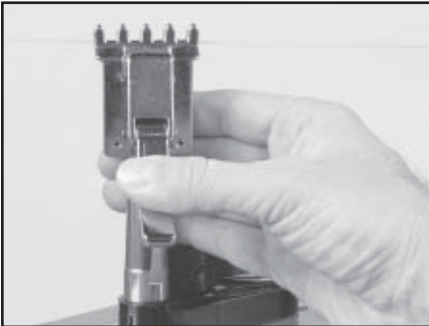

Clamp Head Operation

Cam-Lock Clamps are of a dual action design where as the clamp head and clamp base operate independently of one another.

To clamp a string, lift the clamp head and place the string between the jaws and depress the clamp head lever to secure the string. The clamping pressure applied to the string should be adjusted to provide sufficient pressure to secure the string when subjected to the desired pulling tension. The

diamond coated gripper plates provide for increased friction between the clamps and the string to allow for reduced clamping pressure while securing and holding the string under tension.



Clamp Base Operation

Rotate the Base Locking Lever clockwise to secure the clamp base to the turntable.

Reverse the clamping procedure to unlock the string clamp. The Locking Lever is spring loaded to assist the unlocking of the clamp base.

The Locking Levers should be tightened enough to prevent clamp base slippage on the turntable, when the desired tension is placed on the string. To go from the loose position to the clamped position and back, generally re-

quires the travel permitted by the clamp base. If the travel is not sufficient to allow smooth operation of, adjust the Clamp Base as outlined on page 14.

STRINGING THE FRAME

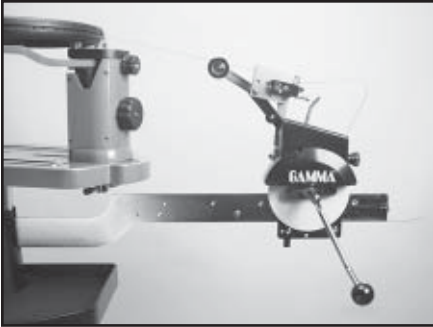

Pulling Tension

Wrap the loose section of string once around the roller and insert the string between the diamond dust coated string gripper plates. Pull the string perpendicular to the gripper plates while slowly rotating the tensioner crank clockwise until the brake lever pops out of the latching block. The string is now tensioned and can be clamped in place with the remaining fixed clamp.

Repeat the above steps until all main strings are installed. Tie off ends of main strings as per racquet manufacturers recommendations.



Clamping the First Main String

To begin stringing the main strings, thread the two ends of the string through the two center holes at the appropriate end of the frame and continue through the opposite center holes. Thread one end of the string through the adjacent grommet hole and pull excess by hand. Secure one of the strings using a string clamp.

Pull the remaining end of the string with the tensioner to the desired tension. Secure the string with the remaining clamp.

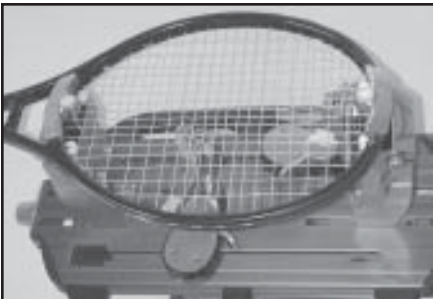

Completing the String Job

Weave the cross strings over and under the main strings being careful to alternate the weave direction of each consecutive cross string so as to be opposite of the previously installed cross string.

Once the final cross string is tensioned and clamped, tie off at the appropriate hole specified by the racquet manufacturer.

PATHFINDERAWL



The GAMMA 6004 includes the Pathfinder stringing awl which creates a pathway between or around strings and through tight grommets.

Insert the awl through the grommet hole in the same manner as for traditional awls. The Pathfinder awl must be closed before insertion.

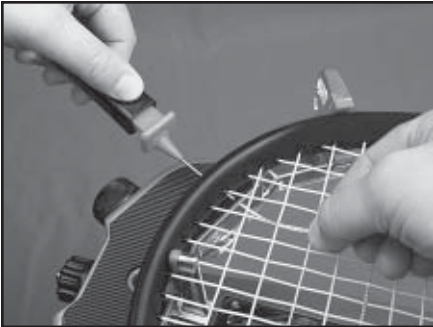

Once the awl is inserted, pull the handle of the awl outward while holding the tip section in place, leaving the outer sheath in the grommet hole.

Insert the end of the string into the center of the sheath.



While holding pressure on the string, slowly pull the sheath out of the grommet hole to leave the end of the string exposed.

MAINTENANCE & ADJUSTMENTS

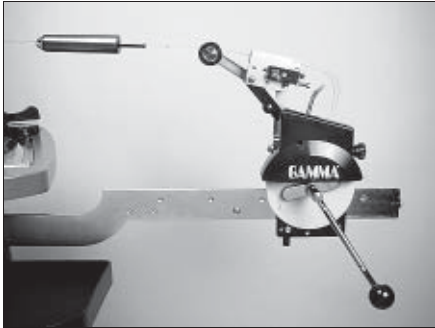

Tension Calibration Procedure

Step 1

Set the tension to 60 lbs. as indicated by the linear scale and rotary knob. Place the string on one end of a tension calibrator into a string clamp and secure. Place string located on the other end of the calibrator into the string tensioner and apply tension. If the brake lever releases before 60 lbs. or after 60 lbs., the tension head should be calibrated as follows.

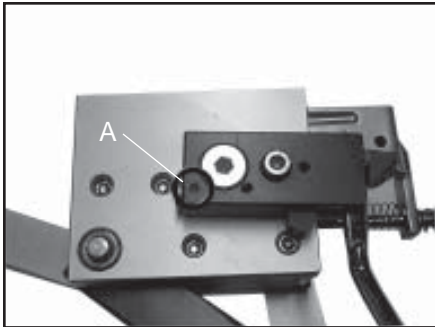

Step 2

Loosen the 1.5 mm locking set screw (A) located on the side of the latching block as shown. The set screw is used to hold the adjustment screw in place.

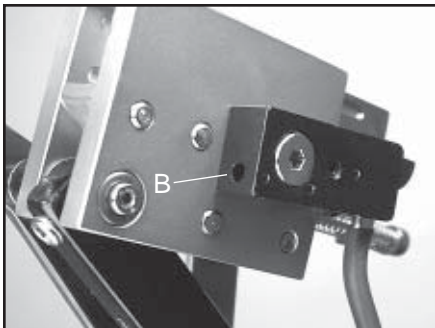

Step 3

If the lever releases before 60 lbs., using the supplied L-shaped hex wrench, turn the adjustment screw (B) located on the left side of the latch block counter-clockwise to increase the engagement of the brake release latch with the brake lever. Repeat step 1 and adjust until the correct tension is indicated on the calibrator.

If the tension indicated in step 1 is greater than 60 lbs., turn the adjustment screw clockwise to reduce the engagement of the brake release latch with the brake lever. Repeat step 1 and adjust until the correct tension is indicated on the calibrator.

MAINTENANCE & ADJUSTMENTS

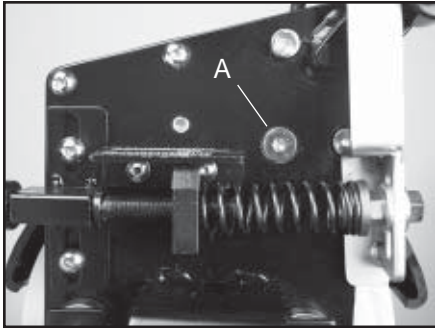

A - Lock Bolt

Adjusting the Tensioner Brake

Step 1

After stringing many racquets, the brake of the tensioner may need to be adjusted.

With the brake lever engaged, loosen the lock bolt located on the back side of the tensioner frame with the 4mm hex wrench.

Note: The lock bolt should only be loosened enough to be turned by hand and must not be removed completely.

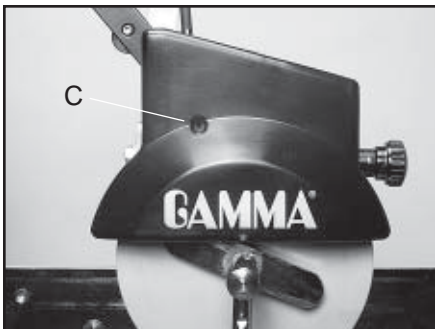

C - Brake Lever Adjustment Bolt

Adjusting the Tensioner Brake

Step 2

With the lock bolt loosened and the brake lever engaged in the latch, insert the 6 mm hex wrench through the hole in the tensioner cover and into the (C) brake lever adjusting bolt.

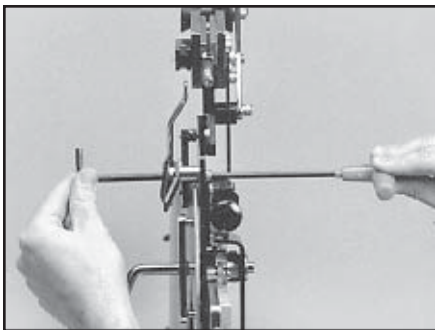

Adjusting the Tensioner Brake

Step 3

To tighten the braking mechanism, turn the brake lever adjusting bolt counter clockwise by about 1/8 turn. Retighten the lock bolt on the back side of the tensioner frame and check for brake tightness. The tensioner should move freely along the track with the brake lever engaged and should hold tension with the brake lever released. If more adjustment is needed, repeat steps above until properly adjusted.

Note: Cover Removed For Clarity

MAINTENANCE & ADJUSTMENTS

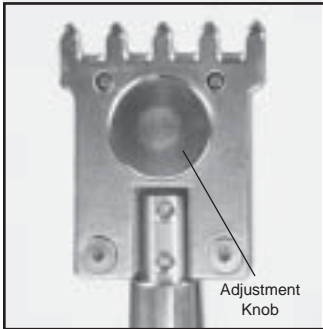

String Clamp Adjustment

The string clamps will need minor adjustments according to string type, construction, and gauge.

To adjust the gap (clamping pressure) between the clamp jaws, insert the string through the racquet as if you were beginning the main strings. Clamp the string and pull tension. If the string slips through the jaws of the clamp, tighten the clamp by compressing the clamp jaws together by hand while turning the Adjustment Knob, in the clockwise direction. If the clamp leaves impressions or damages the string, it may be excessively tight and should be adjusted by turning the Adjustment knob counter clockwise to open the gap between the jaws.

The clamp jaws should be cleaned periodically to be free from dirt, oil, and any string coating for them to grip properly.

Note: The string clamps supplied with your stringing machine can accommodate tight string patterns such as badminton. Depending on the string pattern, the clamp may spread the strings slightly which will not compromise the quality of the string job.

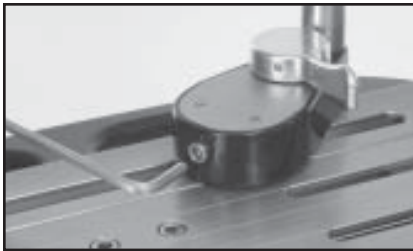

Switch Action Clamp Base Adjustment

If the Switch Action clamp bases slip on the turntable, the base locking levers may need adjusted. Turn the hex screw clockwise to tighten the clamp and counterclockwise to loosen. If frequent adjustment is needed, remove the adjustment screw and tighten the two screws underneath of the clamp. Re-install the adjustment screw.



Switch Action Clamp Base Removal

If the Switch Action clamp base needs to be removed, undo the 2 screws holding the FPR stop, underneath of the turntable. Remove the FRP stop and clamp for cleaning, adjustment or replacement.

MAINTENANCE & ADJUSTMENTS

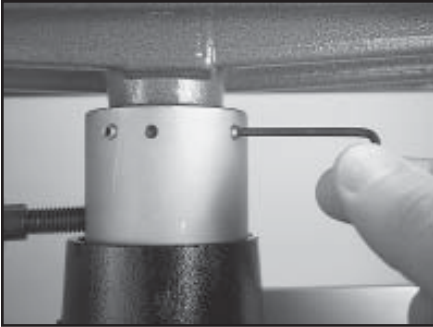

Turntable Brake Pad Replacement

Loosen the four set screws located at the top of the turntable tube until the turntable and turntable flanged pin can be lifted from the support tube.



Insert the 2.5 mm L-shaped wrench into the flat head screw located on the inner side of the brake pad and the end of the brake lever bolt. While holding the locking lever bolt, turn the head of the screw counterclockwise with the wrench to loosen the brake pad. Carefully remove the turntable pad screw.

Pull the brake pad toward the center of the tube to remove the pad from the end of the brake lever. Lift the brake pad from the tube.



Place the new brake pad into the turntable tube. Insert the end of the brake lever bolt into the hole in the of the brake pad until the brake pad rests on the shoulder of the bolt.

Insert the flat head screw into the end of the brake lever bolt from the inner side of the brake pad. While holding the head of the screw with the 2.5MM L-shaped wrench, turn the lever bolt to secure the brake pad against the shoulder of the lever bolt and set the head of the screw below the brake pad surface. Turn the lever to retract the pad until it sets against the inner surface of the turn-

table tube which provides clearance for installation of the turntable. Re-install the turntable and tighten the 4 set screws to secure the turntable to the turntable tube.

TROUBLESHOOTING TIPS

PROBLEM	SOLUTION
String slips in clamps	<ul style="list-style-type: none">- Adjust gap between jaws- Clean clamp jaws
String slips in gripper	<ul style="list-style-type: none">- Clean gripper jaws- Adjust Gripper Jaw Stop Screw
String clamp base slips on turntable.	<ul style="list-style-type: none">- Adjust Base Locking Levers- Clean Turntable Clamp Glide Rails
Tensioner slips on Tensioner Bar after brake lever is released.	<ul style="list-style-type: none">- Adjust tensioner brake lever- Clean tensioner brake disc
String tension too tight or too loose	<ul style="list-style-type: none">- Check tension using a tension calibrator and adjust machine calibration if necessary

For additional assistance, contact Customer Service

CARE and CLEANING

With time and use, the clamping surfaces of your machine may become oily or dirty and result in string or clamp slippage while stringing. Periodic cleaning of the following parts is recommended.

String Clamps

Clean the inside gripping surfaces of the string clamp jaws by inserting a cloth or pipe cleaner soaked with isopropyl alcohol between the jaws and rub back and forth. If the build-up is excessive, dismantle the string clamp jaws to expose the gripping surfaces by removing the adjustment knob. Using a small nylon brush, (such as a toothbrush), scrub the inside surfaces until all debris is removed. Clean the jaws with isopropyl alcohol and re-assemble.

String Clamp Base

Clean the base of the clamps and the top of the turntable with isopropyl alcohol.

String Gripper

Clean inner gripping surfaces with isopropyl alcohol soaked cloth or pipe cleaner.

COMPONENT IDENTIFICATION

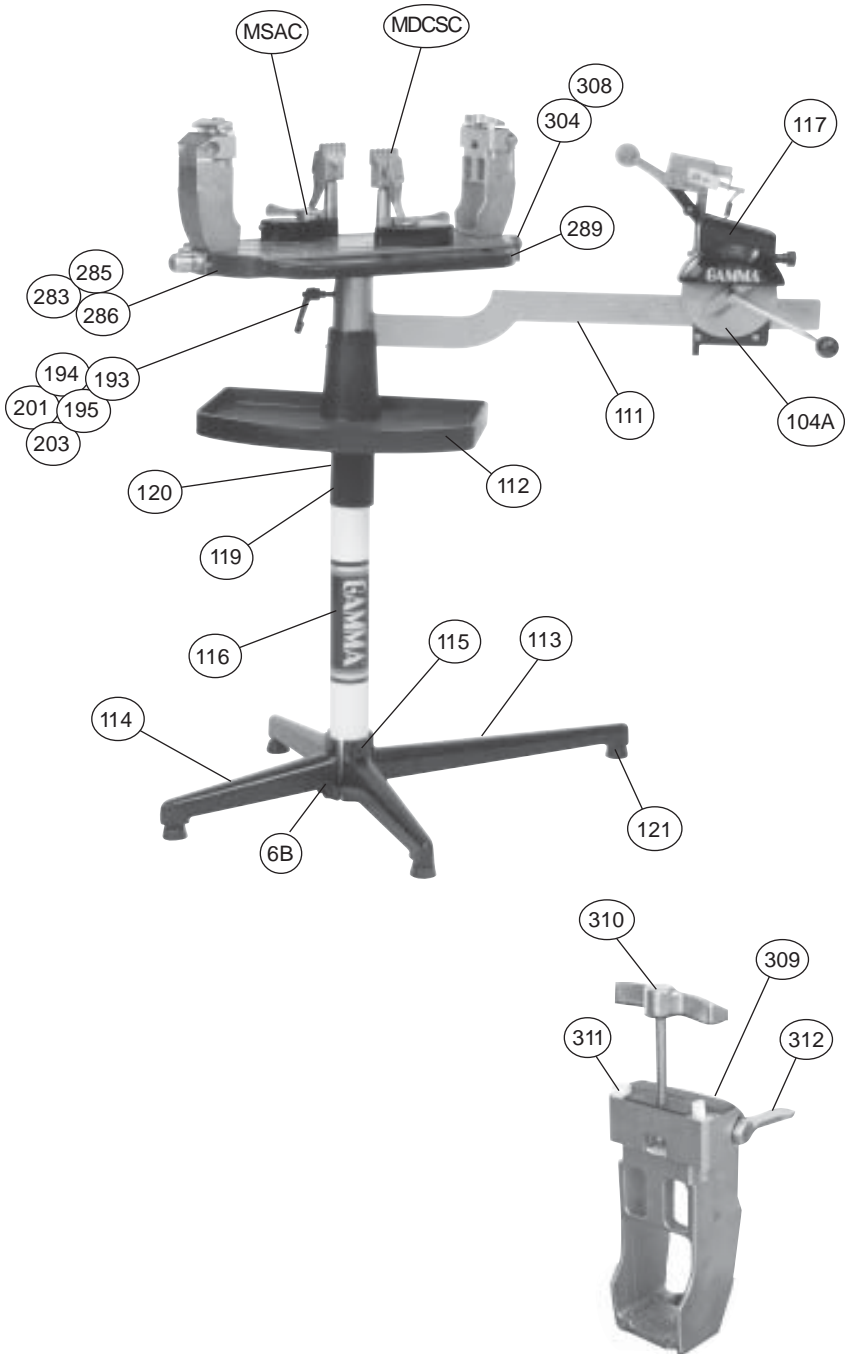

PARTS LIST

PART #	DESCRIPTION		TOOLS AND ACCESSORIES
6B	CAP SCREW - M8x30	98	BOX WRENCH - 10MM
104A	TENSIONER ASSEMBLY	109	NEEDLE NOSE PLIERS
111	TENSIONER TRACK	110	BENT NOSE PLIERS
112	TOOL TRAY	171	CUTTING PLIERS
113	STAND LEG - LONG	251	LONG HEX WRENCH SET - 9 PC.
114	STAND LEG - SHORT	MBFC	BADMINTON FLYING CLAMP
115	FLAT HEAD SCREW - M8x28	MPSA	PATHFINDER AWL
116	LOWER COLUMN SUPPORT	MA	STRINGER SAWL
117	TENSIONER COVER	MPG	STARTING CLAMP
119	BELLOWS		
120	UPPER COLUMN SUPPORT		
121	LEVELING FOOT		
173	TURNTABLE - FLANGE PIN		
193	TURNTABLE BRAKE LEVER		
194	TURNTABLE BRAKE PAD		
195	TT. BRAKE PAD SCREW		
199	FLANGED TURNTABLE PIN		
201	TT. BRAKE COLLAR		
203	TT. PIN CAP SCREW		
304	SC KNOB		
308	SC TURNTABLE		
309	2 PT PAD		
310	2 PT HOLD DOWN		
311	2 PT RQT SUPPORTS		
312	2 PT LEVER		
MDCSC	DIECAST METAL STRING CLAMP		
MSAC	SWITCH ACTION CLAMP BASE		