

GAMMA[®]

PROGRESSION

200

STRINGING MACHINE



OWNER'S MANUAL

Issue 1A - December 2012

GAMMA[®]

PROGRESSION

200

MP200-10 OWNER'S MANUAL

TABLE OF CONTENTS

WARRANTY	PAGE 2
FEATURES.....	PAGE 3
ASSEMBLY INSTRUCTIONS	PAGE 4
MOUNTING THE FRAME	PAGE 6
STRINGING THE FRAME.....	PAGE 8
PATHFINDER AWL.....	PAGE 10
MAINTENANCE & ADJUSTMENT	PAGE 11
TROUBLE SHOOTING TIPS	PAGE 12
NOTES.....	PAGE 13
PARTS LIST	PAGE 14
PARTS DRAWING.....	PAGE 15

LIMITED LIFETIME WARRANTY

GAMMA Sports (GAMMA) warrants to the original purchaser that the Progression 200 stringing machine ("EQUIPMENT") purchased is free from defects in materials and workmanship for life of the EQUIPMENT. Should any defects develop under normal use, GAMMA will at its option, repair or replace the defective EQUIPMENT provided it is returned to GAMMA prepaid at the purchaser's expense. This warranty does not apply to any damage or defect caused by negligence, abuse, misuse, unauthorized alteration, shipping, handling, or part wear and tear as a result of normal use.

Routine maintenance, adjustment, and cleaning required to ensure proper operation are the responsibility of the purchaser and are not covered under the terms of this warranty. These include, but are not limited to: String Clamp adjustment, as described on page 4.

GAMMA's obligation under this warranty is limited to repair or replacement of defective EQUIPMENT, and no one is authorized to promise any other liability. GAMMA shall in no event be liable for any incidental or consequential damages.

To return defective EQUIPMENT, a return authorization (RA#) must be obtained from a GAMMA customer service representative by calling 800-333-0337. The RA# must be marked on the outside of the shipping carton being returned. All returns must be shipped prepaid by the customer to GAMMA. Please retain the original shipping carton and packing materials for any future shipments. GAMMA will not be responsible for machines which are not sent in the original undamaged packaging.

FEATURES



MACHINE FEATURES

- ❖ Drop Weight Tensioner w/ 9 to 90lb range and Permanently Engraved Weight Scale
- ❖ Patented Parallel Jaw Rotating Ratchet Gripper w/ Diamond Dust Coated Gripping Surfaces
- ❖ Two Point Racquet Mounting System- Accommodates All Racquets
- ❖ Two Advanced Composite Floating Clamps w/ Thumb Screw Adjustment
- ❖ Durable Polystyrene Base Cover w/ Convenient Padded Tool Tray
- ❖ Strong, Light Weight, Powder Coated Molded Aluminum Construction Tray

ASSEMBLY INSTRUCTIONS

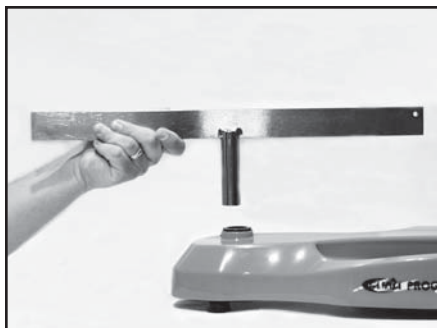

Installing the Turntable

Insert the turntable center post into the bushing assembly of the machine base.

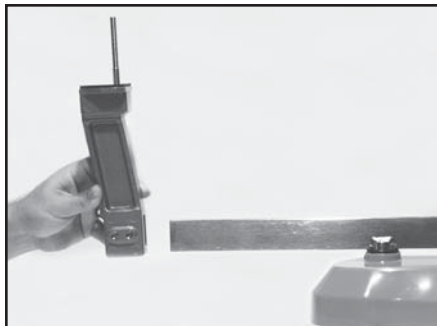

Installing the Support Posts

Slide each support post onto the end of the turntable bar. The posts should be oriented so as to angle away from the turntable center post.



Installing the Drop Weight

Remove the end cap from the tension bar and slide the drop weight onto the bar. The weight should be oriented with the knob end closest to the string winder. Replace the end cap.

ASSEMBLY INSTRUCTIONS

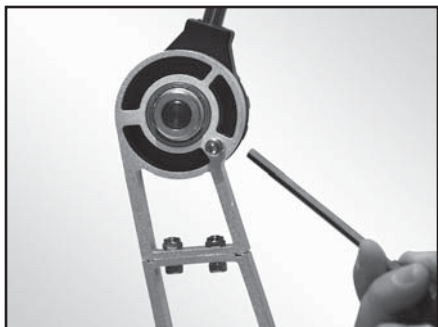

Tension Bar Stop Screw

Raise the Tension Bar to an upright position. Using the supplied 5MM wrench, securely tighten the Stop Screw. This will prevent the Tension bar from contacting the racquet frame.

MOUNTING THE RACQUET



Installing the Racquet Support Adapters

The machine is supplied with two styles of Racquet Support Adapters. A thick profile adapter for wide body racquets and a thin profile adapter for conventional racquet frames. The Adapters are also tapered, use the highest side of the adapter that does not interfere with the string grommet holes.

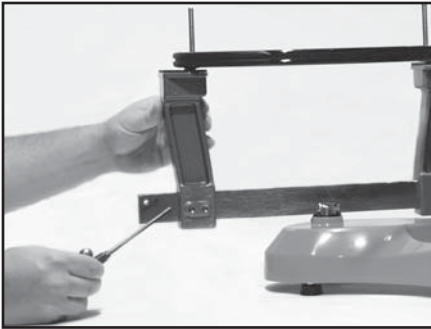

Adjusting the Frame Support Posts

Place the racquet frame over the center posts and onto the frame support posts. Loosen the locking screws on one support post and slide the post in the appropriate direction until the plastic adapter contacts the frame. Securely tighten the locking screws. Adjust the opposite post in the same manner.

Note: It is extremely important both plastic adapters are in contact with the frame to prevent racquet damage.

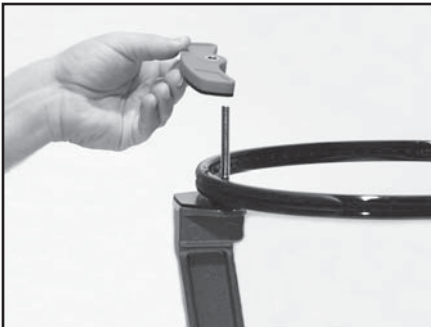

Securing the Racquet

With the frame support posts properly adjusted, place the frame hold down clamps over the center screws and tighten the clamp bar knobs securely. Do not overtighten the knobs as frame damage may occur.

Note: Inverted throat racquet frames may require the throat clamp plate to be rotated 180 degrees to match the frame.

STRINGING THE FRAME

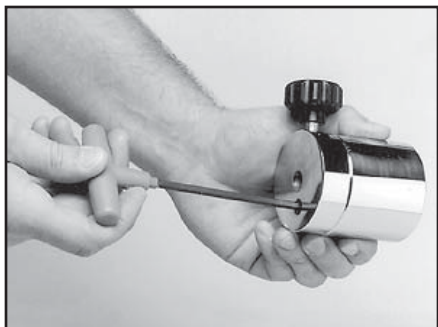

Setting Tension

The drop weight is of a two piece design. When assembled, it will accommodate tensions from 20 to 90 lbs. For tensions from 8 to 20 lbs., remove the 5mm bolt on the face of the drop weight, and use the smaller portion of the weight as described above.

Note: Tensions above 77lbs. require removal of the drop weight bar end cap.



To set the stringing tension, loosen the locking knob on the side of the drop weight. Slide the weight in the appropriate direction until the face **closest** to the string gripper is indexed with the desired tension mark on the tension bar.

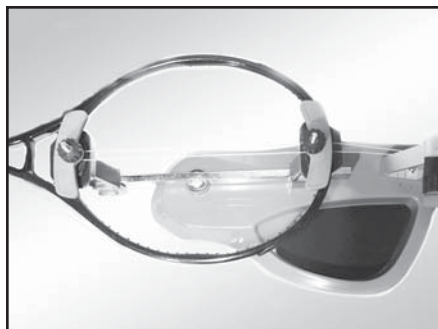

Starting the Main Strings

To begin stringing the main strings, count the number of holes at the throat of the frame, which will determine the starting point. For racquets with 4 or 8 holes at the throat, the main strings will begin at the head. For racquets with 2 or 6 holes at the throat, the main strings will begin at the throat.

Thread the two ends of the string through the two center grommet holes at the head or throat as determined in the previous step. Route the strings through the opposite center holes.

STRINGING THE FRAME

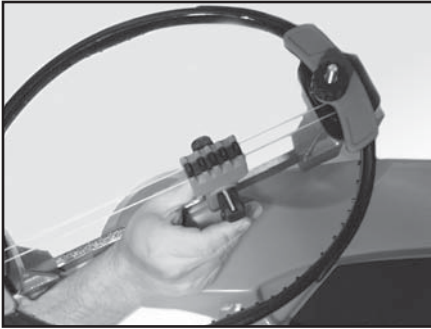

Clamping the First Main String

Thread one end of the string through the adjacent grommet hole and pull excess by hand. Clamp both the center and the adjacent string to each other on the inside of the frame.

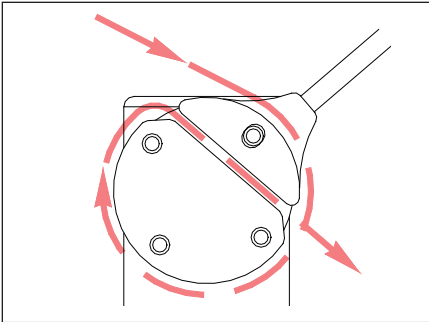

Pulling Tension

Wrap the free string clockwise around the gripper drum once and position between the gripper jaw.

Gently turn the gripper clockwise while squeezing the jaws together until all slack in the string is removed.

Note: For proper operation, the string gripper jaw must be in the position shown. The tension in the string provides the clamping force to the jaws.

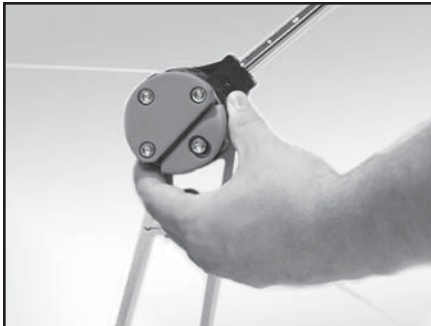

While holding the string gripper drum with your hand, lift the tension bar to approximately 45 degree angle and let fall. If the tension bar drops below horizontal, repeat the above action until the bar comes to rest parallel to the racquet. The set tension will be reached when the bar rests horizontal.

If the bar comes to rest above horizontal, release the string and re-pull tension.

Manually forcing the bar into the horizontal position will greatly increase string tension and may result in racquet damage.

STRINGING THE FRAME

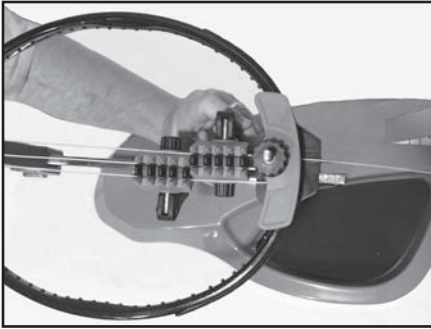

Clamping the String

Clamp the tensioned string to the next adjacent string using the second string clamp.

Release the tensioned string by raising the tension arm.

Repeat the procedure for all of the remaining main strings and tie off following the racquet manufacturers recommendations.

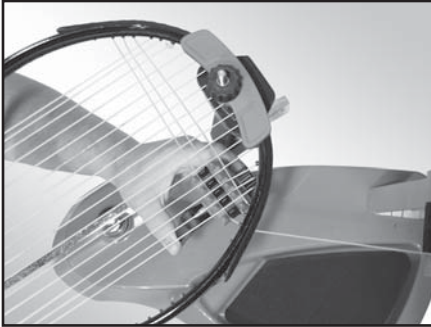

Starting the Cross Strings

Follow the manufacturer's recommended stringing pattern for one or two piece stringing. This will determine the starting point for the cross strings. Weave the first two cross strings and pull tension and clamp the cross strings to each other.

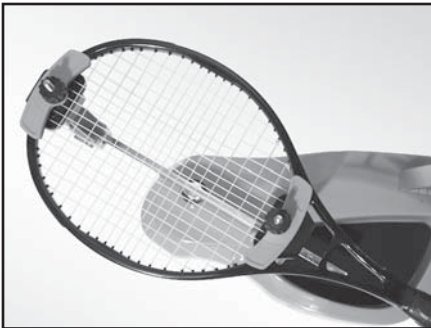

Finishing the String Job

Weave and tension the remaining cross strings and tie off at the specified grommet hole.

Remove the strung racquet from the reverse order of mounting.

PATHFINDER AWL



The machine includes the pathfinder stringing awl which creates a pathway between or around strings to make inserting a string through blocked grommets easier and quicker.

Insert the awl through the grommet hole in the same manner as for traditional awls. The Pathfinder awl must be in the closed position before insertion.

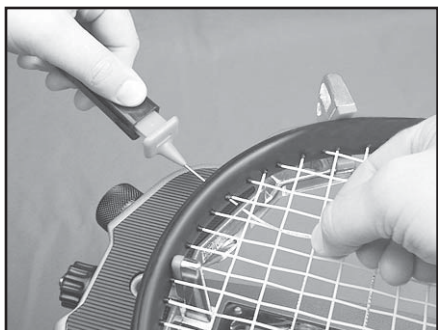

Once the awl is inserted, pull the handle of the awl outward while holding the tip section in place. This leaves the outer sheath in the grommet hole. Insert the end of the string into the outer sheath.

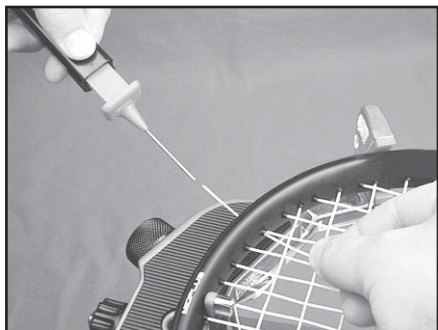

While holding the string, slowly pull the sheath out of the grommet hole to leave the free end of the string exposed.

MAINTENANCE & ADJUSTMENTS

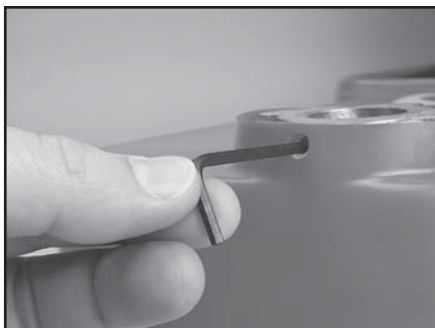

Turntable Bushing Adjustment

The turntable bushing is adjusted at the factory for optimum performance. After time and use, the turntable bushings may need minor adjustment. An adjustment is indicated when noticeable turntable looseness or wobble occurs while stringing.

To adjust the fit between the turntable pin and the bushings, tighten the set screw at the top of the bushing using a 3mm hex wrench. Tighten until the turntable rotates smoothly without excessive free play.



Clamp Adjustment

The floating clamps provided with your machine will need minor adjustments according to what string type, construction, and gauge you are using.

If the strings slip through the jaws of the clamp, tighten the clamp by turning the thumb knob opposite of the handle, in the clockwise direction. If the clamps leave impressions or damages the string, they are too tight and the thumb wheel must be turned counterclockwise.

The clamp jaws must be clean and free from dirt, oil, and any string coating for them to grip properly. Keep the clamp jaws clean with isopropyl alcohol.

TROUBLESHOOTING TIPS

PROBLEM

SOLUTION

String slips in clamps

- Adjust gap between clamp jaws
- Clean clamp jaws

String slips in gripper

- Clean gripper jaws
- Make sure string is wrapped over top gripper prior to inserting between gripper jaws

CARE & CLEANING

With time and use, the clamping surfaces of your machine may become oily or dirty and result in string or clamp slippage while stringing. Periodic cleaning of the String Clamps and String Gripper is recommended. Knife sharpening stones work well for cleaning the diamond coated string clamping surfaces. Cleaning with a solvent such as isopropyl alcohol and a mild abrasive tool such as a toothbrush also works well to remove oily or greasy build up.

NOTES

PARTS LIST

<u>PART #</u>	<u>DESCRIPTION</u>	<u>TOOLS & ACCESSORIES</u>	
4A	TURNTABLE BUSHING	70	5MM T-HANDLE HEX WRENCH*
5	RUBBER FOOT	98	BOX WRENCH- 10MM*
6A	CAP SCREW- M8x25	108	UTILITY KNIFE*
8A	SET SCREW- M5x6	109	NEEDLE NOSE PLIERS*
24	KNOB	315	TURNTABLE RAISE RING
25	TENSION BAR	MA	STRINGER'S AWL*
26	TENSION BAR CAP	MPSA	PATHFINDER AWL*
27	DROP WEIGHT KNOB		* (NOT SHOWN)
28	FRONT WEIGHT- BADMINTON		
29	BACK WEIGHT		
30	TENSION BAR DRUM		
30A	SET SCREW		
31	STRING GRIPPER DRUM		
47	FLOATING CLAMP KNOB		
48	SWING BOLT		
49	RETURN SPRING		
50	PIVOT PIN		
51	RETAINING RING		
78	CLAMP PLATE		
79	CLAMP PLATE PAD		
82	FRAME SUPPORT SHORT		
82A	FRAME SUPPORT TALL		
83A	TENSION BAR STOP SCREW		
92	TURNTABLE		
93	SUPPORT POST		
94	SUPPORT POST PIN		
95	SUPPORT POST PAD		
161	WINDER BEARING		
162	GRIPPER PIVOT PIN		
163	PIVOT PIN RETAINER COLLAR		
257	LOWER WINDER STAND		
258	UPPER WINDER STAND		
316	BASE		
350	BASE COVER		
MPFC	FLOATING CLAMP		
MRSG	ROTATIONAL GRIPPER		

<u>OPTIONAL TOOLS & ACCESS</u>	
MBFC	BADM FLOATING CLAMP
MPMC	MACHINE COVER
MPG	STARTING CLAMP
MPS	CLEANING STONE
SGSM	STRINGER'S MAT

PARTS DRAWING

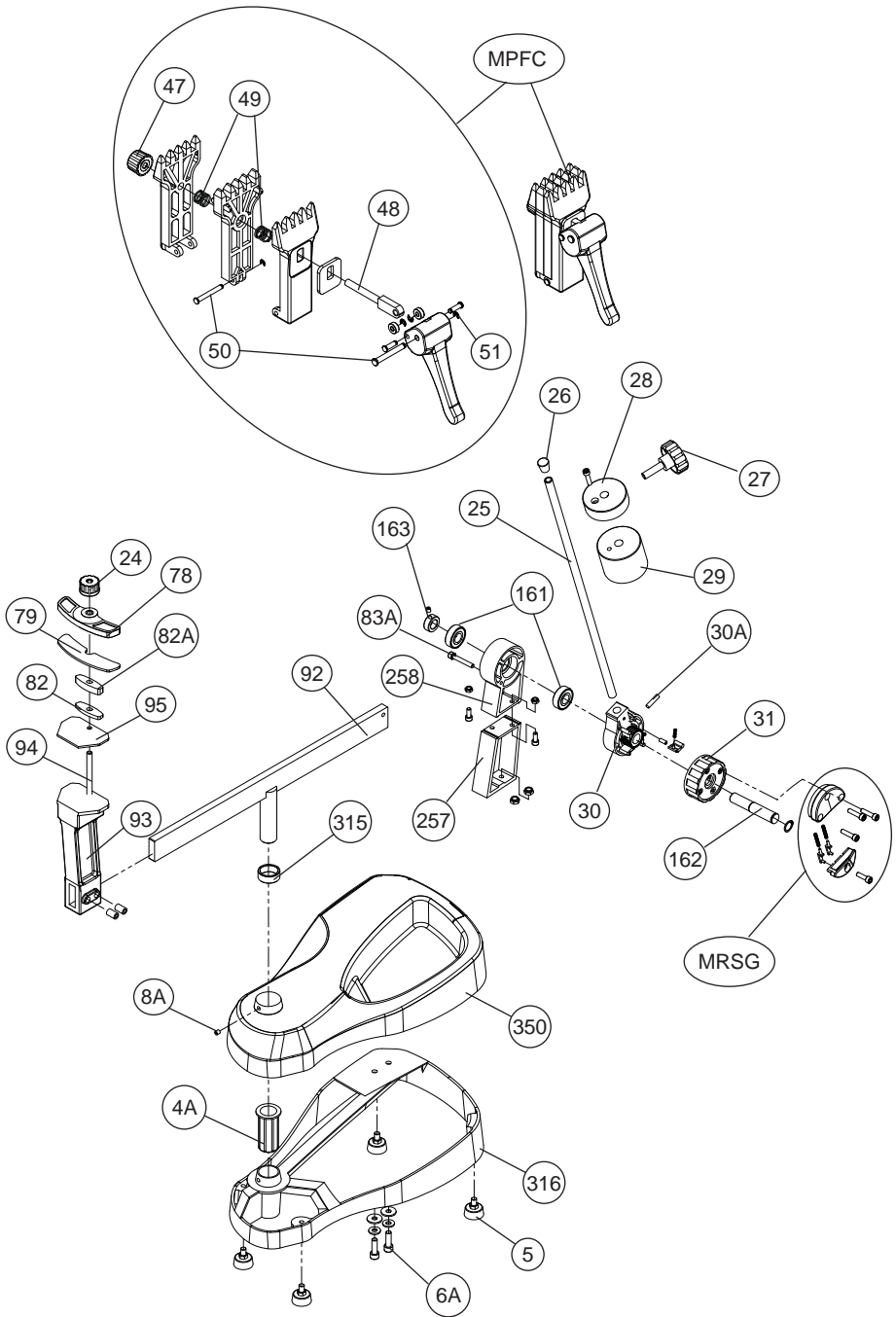



MMAN-14

GAMMA SPORTS

200 Waterfront Drive

Pittsburgh, Pennsylvania 15222

Phone: 800.333.0337 Fax: 412.323.0317

Visit our website at www.gammasports.com